



WDC10  
InstaShow™  
User Manual



# Copyright

Copyright © 2016 by BenQ Corporation. All rights reserved. No part of this publication may be reproduced, transmitted, transcribed, stored in a retrieval system or translated into any language or computer language, in any form or by any means, electronic, mechanical, magnetic, optical, chemical, manual or otherwise, without the prior written permission of BenQ Corporation.

# Disclaimer

BenQ Corporation makes no representations or warranties, either expressed or implied, with respect to the contents hereof and specifically disclaims any warranties, merchantability or fitness for any particular purpose. Further, BenQ Corporation reserves the right to revise this publication and to make changes from time to time in the contents hereof without obligation of BenQ Corporation to notify any person of such revision or changes.

This user manual aims to provide the most updated and accurate information to customers, and thus all contents may be modified from time to time without prior notice. Please visit [www.benq.com](http://www.benq.com) for the latest version of this manual.

The illustrations and the images in this guide are for your reference.

# BenQ ecoFACTS

BenQ has been dedicated to the design and development of greener product as part of its aspiration to realize the ideal of the “Bringing Enjoyment 'N Quality to Life” corporate vision with the ultimate goal to achieve a low-carbon society. Besides meeting international regulatory requirement and standards pertaining to environmental management, BenQ has spared no efforts in pushing our initiatives further to incorporate life cycle design in the aspects of material selection, manufacturing, packaging, transportation, using and disposal of the products. BenQ ecoFACTS label lists key eco-friendly design highlights of each product, hoping to ensure that consumers make informed green choices at purchase. Check out BenQ's CSR Website at <http://csr.BenQ.com/> for more details on BenQ's environmental commitments and achievements.



# Table of contents

Copyright .....	2
Disclaimer .....	2
BenQ ecoFACTS .....	2
Introduction .....	4
Product features .....	4
Package content .....	5
Overview .....	6
InstaShow Button .....	6
InstaShow Host .....	6
Installation .....	8
Assembling InstaShow Host .....	8
Setting up InstaShow Host .....	8
Attaching InstaShow Host to the ceiling .....	9
Attaching InstaShow Host to a ceiling mount .....	9
Placing InstaShow Host on a table .....	10
Installing InstaShow Host on the wall or trolley .....	10
Connecting the HDMI cable and power .....	11
Assembling the adapter .....	11
Connecting the HDMI cable.....	12
Power supply via a USB type A jack (5V/1.5A) .....	12
Power supply via a power adapter.....	13
Setting up and power supply of InstaShow Button .....	13
Using Cable USB A(F) to USB A(M) .....	15
Pairing InstaShow Button and InstaShow Host .....	16
When InstaShow Host is placed on the table .....	16
Waking up InstaShow Host .....	18
Storing InstaShow Buttons in the cradle .....	18
Starting and stopping presentation .....	19
Getting ready .....	19
Starting presentation .....	19
Idle presentation .....	21
Play video with InstaShow™ .....	22
Troubleshooting .....	24
Product specification .....	28

# Introduction

InstaShow™ is a wireless device for corporate meeting rooms. Users expect devices to respond instantly, apps to launch and to control at their fingertips, and information to be available on demand. Instashow™ bypasses the complicated steps of IP addresses, driver installation, app execution, setting selection, etc. to quickly deliver professional, stable visual quality for teams to collaborate freely and confidently. InstaShow™ is an unique all-hardware solution without software issues for universal compatibility and display flexibility.

## Product features

InstaShow™ is equipped with the following features:

Features	Description
True Plug & Play	Simply connect InstaShow™ into your USB and HDMI ports, then push the button to start presenting immediately.
No Software	InstaShow™ doesn't need any software installation or execution. There's no setup, configuration, or waiting for pop-ups to launch. Just plug into your PC or Mac and start presenting immediately.
InstaVideo	Convenient button switches between Presentation mode and Video mode for precise productivity or smooth 1080p video, only from BenQ. See <a href="#">Play video with InstaShow™ on page 22</a> for details.
Auto Channel Selection	InstaShow™ automatically selects the best wireless channel upon boot-up, ensuring smooth presentations in any environment.
Wireless 802.11ac	The latest 802.11ac Wi-Fi guarantees extremely smooth wireless streaming without lag or buffering.
Video and Audio	InstaShow™'s HDMI output supports up to 60Hz Full HD 1080p video and stereo sound without cable clutter or complicated driver selection.
Assured Performance	Peace of mind for consistent wireless presentation performance without relying on your PC.
Extended Desktop	Keep your presenter view, notes, and backup data on your laptop screen while presenting to the wireless screen with extended desktop in both Windows and OS X.



- Transmission distance depends on actual environment. Stated distance is based on line-of-sight measurement. Structures constructed of steel, wood, concrete, or brick may decrease transmission distance.
- According to regulatory restrictions in different regions of the world, Wi-Fi channels cannot be used in countries outside the purchased region.

# Package content

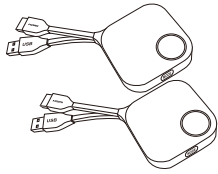

InstaShow Buttons



InstaShow Host

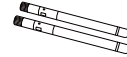

2 Antennas

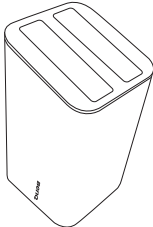

Cradle

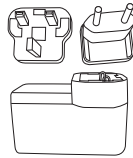

Adapter & Plugs

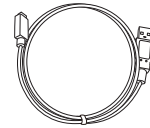

Cable: USB A(M) to Micro B(M)

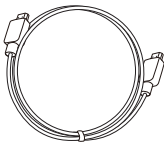

Cable: HDMI A(M) to A(M)

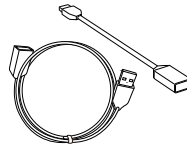

Cable: USB A(F) to USB A(M)

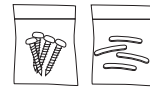

Screws & Rubber Foot

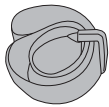

Velcro Strap

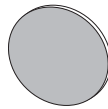

Round Double-sided sponge  
Tape

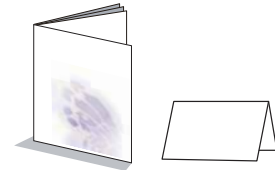

Quick Start Guide & Safety  
Statement



- Available accessories and the pictures shown here may differ from the actual contents and the product supplied for your region.
- Use original accessories to ensure compatibility.
- Always keep the product and accessories out of reach of children.

# Overview

## InstaShow Button

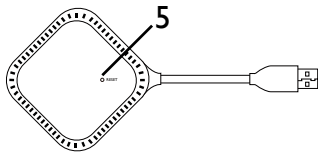
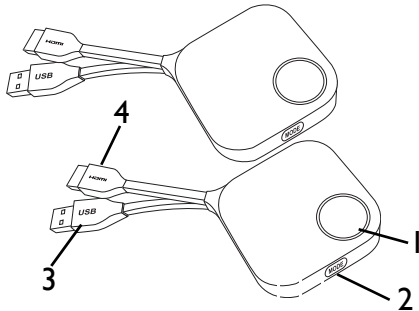

Bottom of InstaShow Button

1. **Present key with LED indicator**  
Press to start or stop presenting.
2. **MODE key**  
Press to pair with InstaShow Host or to switch to Video/Present mode.
3. **USB 3.0 connector**  
Connect to a computer or laptop.
4. **HDMI 1.4 connector**  
Connect to a computer or laptop.
5. **RESET**  
Poke at the **RESET** hole to reset the device if the device stops responding.

## InstaShow Host

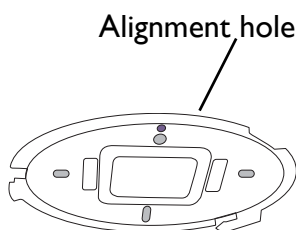
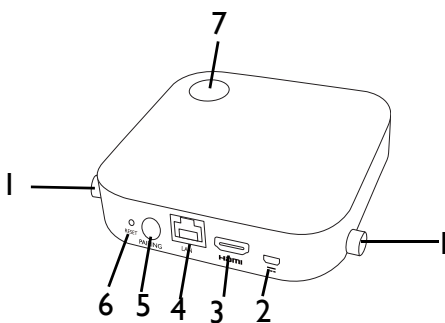

Lid of InstaShow Host

1. **Fixture parts for the Antennas**  
Refer to [Assembling InstaShow Host on page 8](#) for more information.
2. **DC 1.5A port**  
Connect to an adapter or a display using a Cable USB A(M) to Micro B(M).
3. **HDMI port**  
Connect to a display using a Cable HDMI A(M) to A(M).
4. **LAN port**  
Allow users to have access to the web management through network.
5. **PAIRING key**  
Press to pair with InstaShow Button.
6. **RESET**  
Poke at the **RESET** hole to reset the device if the device stops responding.
7. **Power button with LED indicator**  
Press to turn InstaShow Host on and off.
8. **Lid**  
Refer to [Attaching InstaShow Host to the ceiling on page 9](#) for more information.

## LED indicators of InstaShow Button and InstaShow Host

Please refer below for detailed indicator and status description of InstaShow Button and InstaShow Host.

LED indicator on InstaShow Button	Status Description
Static blue	The device is presenting.
Flashing blue	The device is in pairing state for 10 seconds.
Flashing green	The device is upgrading the firmware.
Static green	The device is connected and working normally.
Flashing red	The device is trying to connect to InstaShow Host or encountering a problem.
Static red	The device is starting up.
Off	The device is powered off.
Quick flashing red	The reset process is triggered.

LED indicator on InstaShow Host	Status Description
Static blue	Connected device is presenting.
Flashing blue	The device is in pairing state for two minutes.
Flashing green	The device is upgrading the firmware.
50% static green	The device is in network standby mode.
Static green	The device is on and ready for connection.
Flashing red	The device is encountering a problem.
Static red	The device is starting up.
Off	The device is powered off.
Quick flashing red	The reset process is triggered.

# Installation

This section will guide you on how to prepare the unit before its initial use.

As your InstaShow™ could work with different displays, the steps required to complete the installation may vary according to the actual environment and your display specifications. Follow the procedures below and refer to the specified sections for details.

1. Assemble InstaShow Host with the antennas. See [Assembling InstaShow Host on page 8](#) for details.
2. Connect InstaShow Host to the display and power properly. See [Setting up InstaShow Host on page 8](#) and [Connecting the HDMI cable and power on page 11](#) for details.
3. Connect InstaShow Button to the desired devices and power properly. See [Setting up and power supply of InstaShow Button on page 13](#) for details.
4. Make sure that all the connected devices have been powered on. Press the source button of the display and make sure that the HDMI source has been transmitted. See [Pairing InstaShow Button and InstaShow Host on page 16](#) for details.

## Assembling InstaShow Host

Assemble InstaShow Host with two antennas by turning the antennas clockwise (right) and counterclockwise (left) to fasten them tightly.

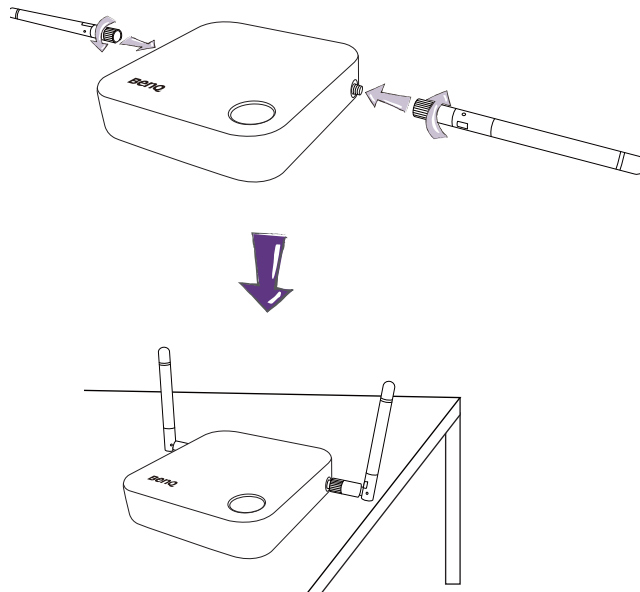

## Setting up InstaShow Host

You are provided with four different ways to position InstaShow Host.



## Attaching InstaShow Host to the ceiling

1. Rotate the lid clockwise until the lid is removed from InstaShow Host.

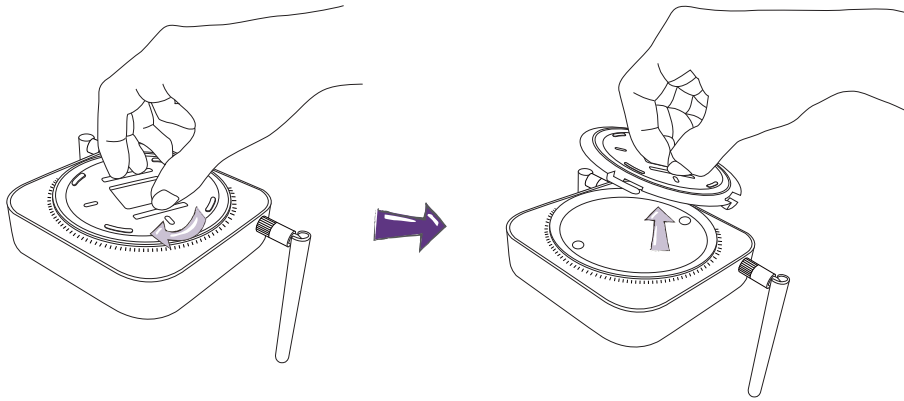

2. Place the lid on the ceiling and locate the alignment hole.
3. Use the screws provided to lock the lid to the ceiling.
4. Lock the first hole (1).
5. Follow the instruction in the illustration below to lock the other holes (2-4).
6. Rotate InstaShow Host counterclockwise to affix InstaShow Host to the lid.

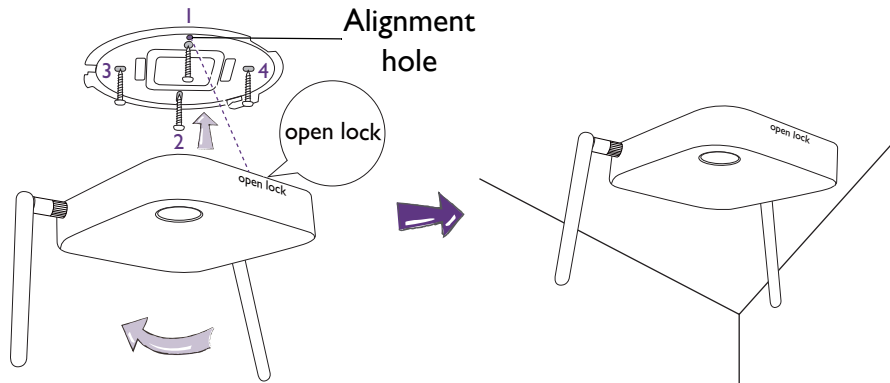

## Attaching InstaShow Host to a ceiling mount

If the display is mounted on the ceiling:

1. Attach InstaShow Host to the ceiling mount using the provided velcro strap.
2. Fix InstaShow Host to the mounting holder.
3. Use the supplied velcro to fix the mounting holder and InstaShow Host to the ceiling mount as shown in the illustration.

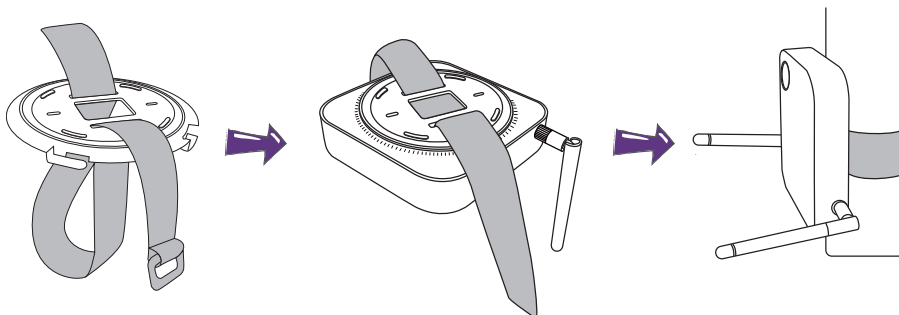

## Placing InstaShow Host on a table

If your display is placed on a table, attach the rubber foot to the recesses on lid of InstaShow Host and put InstaShow Host right next to the display.

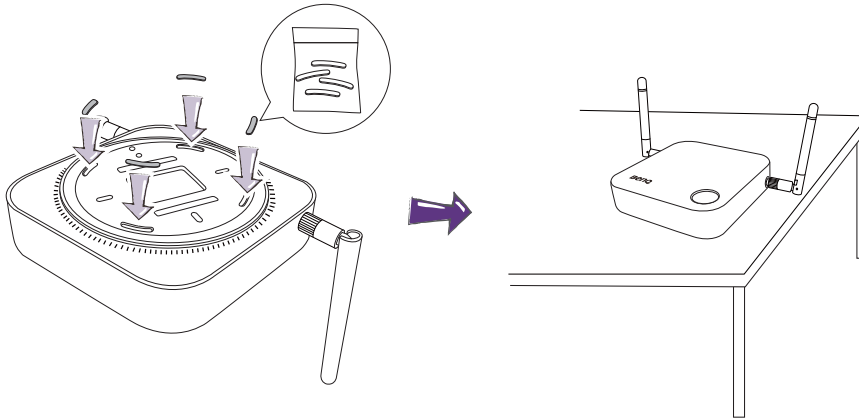

## Installing InstaShow Host on the wall or trolley

If you need to install InstaShow Host near a display:

1. Use the round double-sided sponge tape provided to stick to the lid of InstaShow Host.
2. Affix InstaShow Host on the wall near the display.
3. Keep the antennas away from any signal obstructions.

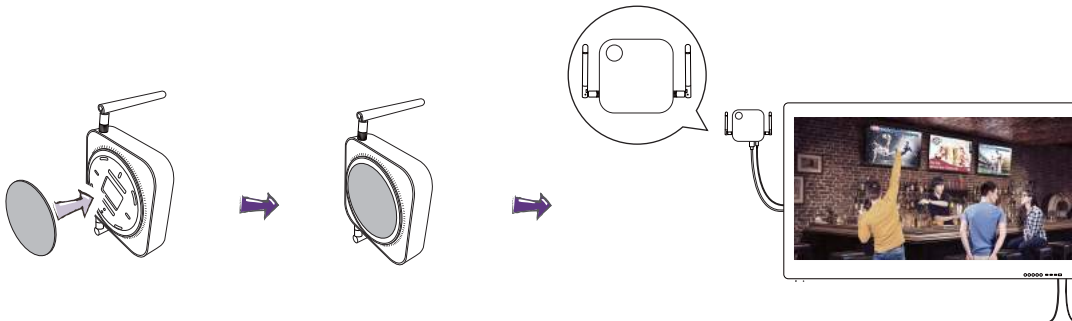

You can also place InstaShow Host on a mobile display trolley. See the illustration.

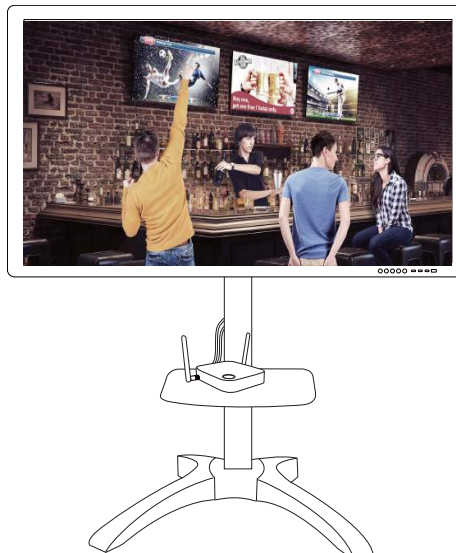

## Connecting the HDMI cable and power

Once InstaShow Host has been positioned properly near the display, connect the HDMI cable and power to ensure signal transmission.

To supply power to InstaShow Host, do one of the following.

Assemble the adapter. See [Assembling the adapter on page 11](#) for details.

- Some of the BenQ projector models may be equipped with a USB type A jack (5V/1.5A) to provide power supply for InstaShow Host. See [Power supply via a USB type A jack \(5V/1.5A\) on page 12](#) for details.
- For display models without a USB type A jack (5V/1.5A) for power supply, see [Power supply via a power adapter on page 13](#) for details.

### Assembling the adapter

Every InstaShow™ adapter has two plug socket options included in the box: standard European and standard British.

To connect the plug of your choice, follow the steps below.

1. Align and insert the bottom hook to the adapter.
2. Close the gap by pushing the plug.
3. The adapter is successfully assembled when it clips into place.

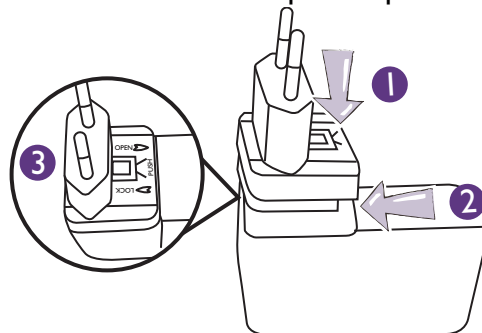

To disconnect the plug, follow the steps below.

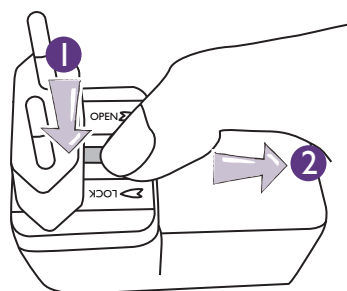

1. Push the latch in the middle.
2. Open the gap by pulling the gap downwards.

## Connecting the HDMI cable

Connect the HDMI cable to the HDMI out jack of InstaShow Host and the HDMI input jack of the projector.

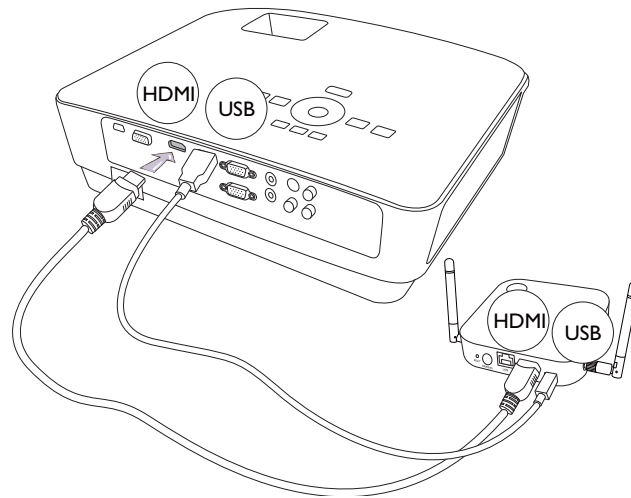

## Power supply via a USB type A jack (5V/1.5A)

Just connect one end of the supplied USB cable to the mini USB jack of InstaShow Host and the other end to the USB type A jack (1.5A) of the BenQ projector. See the illustration.

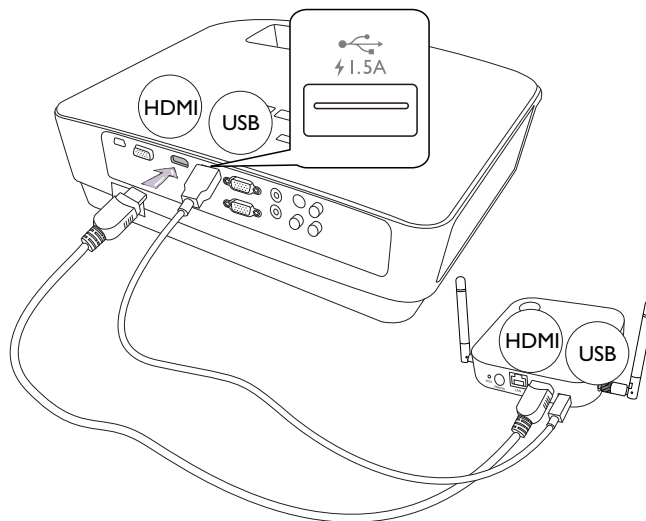

## Power supply via a power adapter

Connect the supplied USB power adapter to the mini USB jack of InstaShow Host and plug the other end into a wall socket. The LED indicator on the power button of InstaShow Host lights up in static red when InstaShow Host is connected to the power mains.

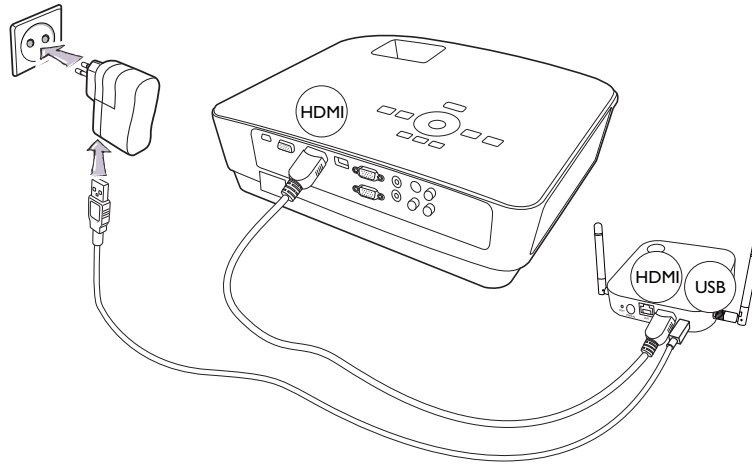

For BenQ IFP (Interactive Flat Panel) products, please have power supply via a power adapter.

## Setting up and power supply of InstaShow Button

1. Connect InstaShow Button's HDMI and USB jacks to the corresponding inputs of a laptop. See the illustration.

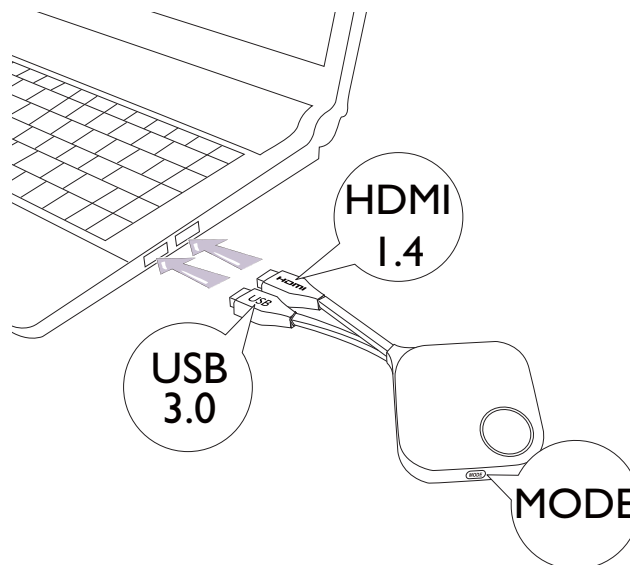

2. The LED indicator of InstaShow Button will turn red when the Button is trying to connect to InstaShow Host.

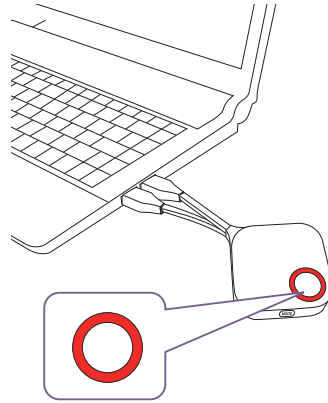

3. Press Present key when the LED indicator turns green.

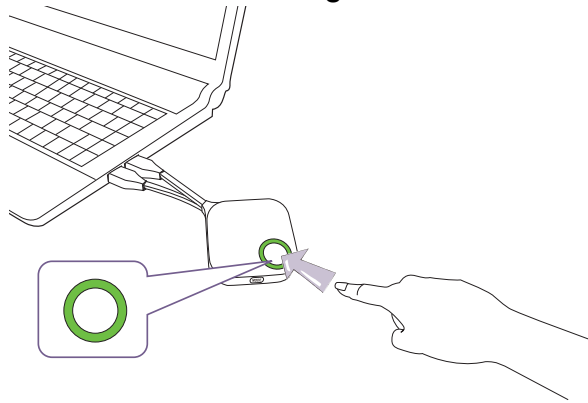

- Handle the Button cable with care. Rough handling might cause defects.
  - Take the plug instead of the cable when inserting or removing InstaShow Buttons.
-

## Using Cable USB A(F) to USB A(M)

Two USB cables are provided for MacBook and Windows laptop users. One is about 15 cm, and the other is about 80 cm to suit your usage situation.

1. Insert the HDMI cable of InstaShow Button to the HDMI converter of your laptop.
2. Connect the cable USB A(F) to your laptop.
3. Connect InstaShow Button's USB jack to the Cable USB A(M).

15cm

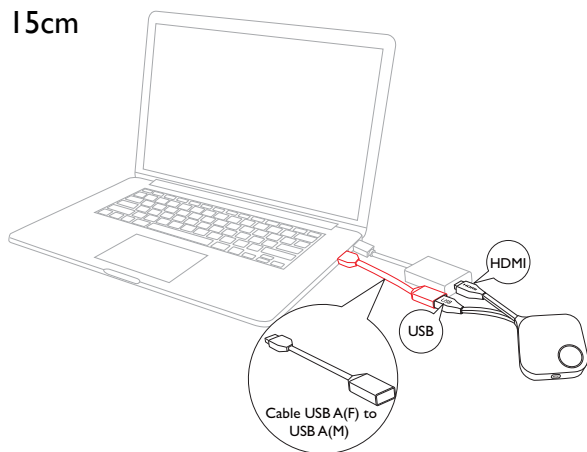

80cm

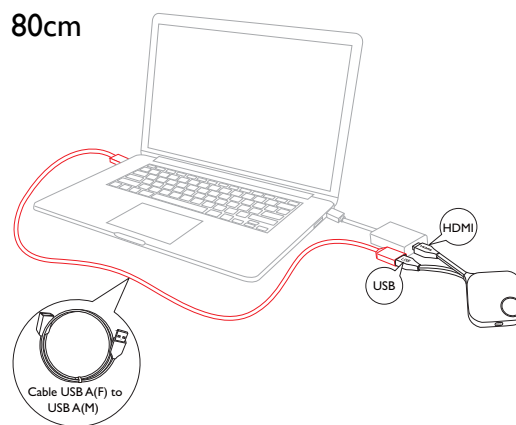

Make sure your own HDMI converter is workable.

# Pairing InstaShow Button and InstaShow Host

A set of InstaShow™ includes an InstaShow Host and two InstaShow Buttons, which are paired before shipment. In that case, you don't need to pair them again. However, if you buy two or more sets of InstaShow™, and you want to pair a Button with a different Host, you need to follow the instruction below. If you buy an additional InstaShow Button kit, and you want to pair the new Buttons with your Host, you need to follow the instruction below as well.

## When InstaShow Host is placed on the table

1. Make sure your InstaShow Host is ready with power supply. Connect InstaShow Button's HDMI and USB jacks to the corresponding inputs of a laptop.

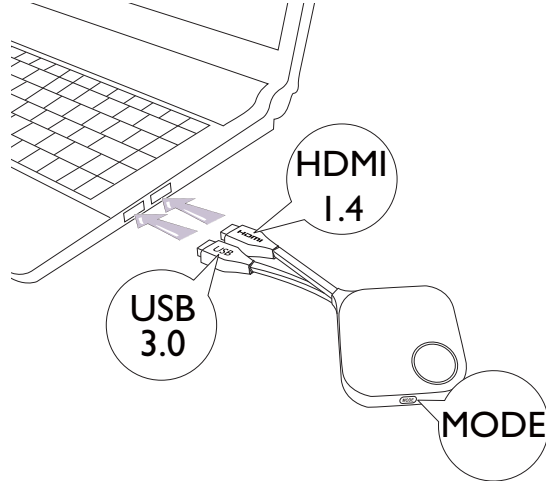

2. When InstaShow Button is connected to the laptop, the LED indicator of InstaShow Button will flash red. InstaShow Button is in pairing mode, waiting to pair with your InstaShow Host.

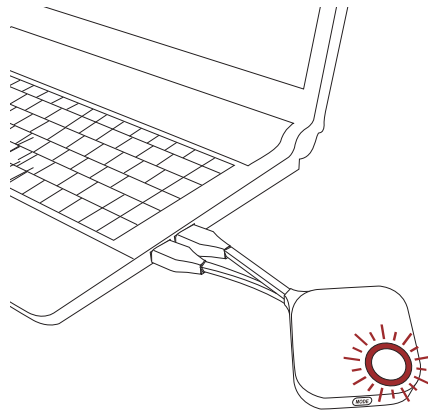

If an InstaShow Button nearby has been paired with an InstaShow Host before, it will turn static green.



3. Press **PAIRING** key of InstaShow Host for five seconds, then the LED indicator of InstaShow Host will blink blue for two minutes, waiting to pair with InstaShow button.

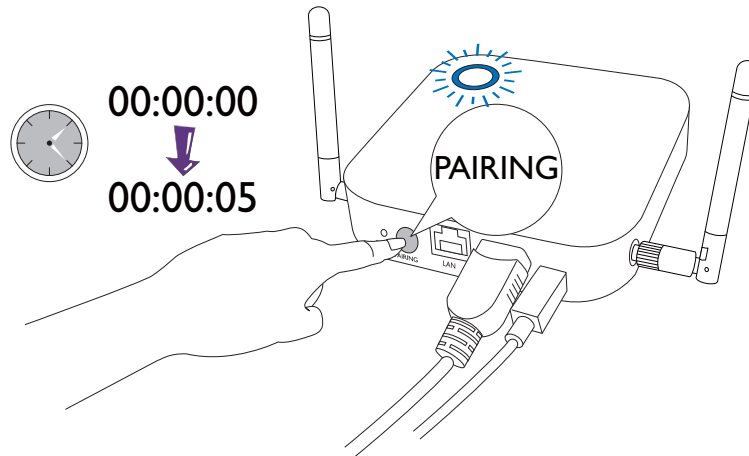

4. Press **MODE** key on the side of InstaShow Button for five seconds. The LED indicator of InstaShow Button will blink blue for about 10 seconds. The pairing process is ongoing. The "Pairing" message will be shown on the screen.

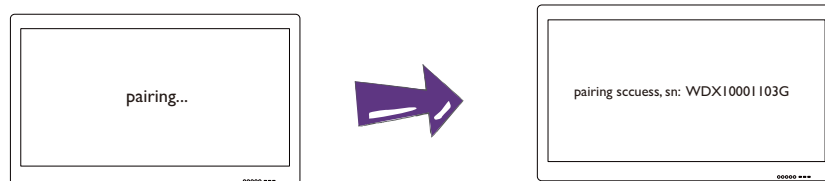
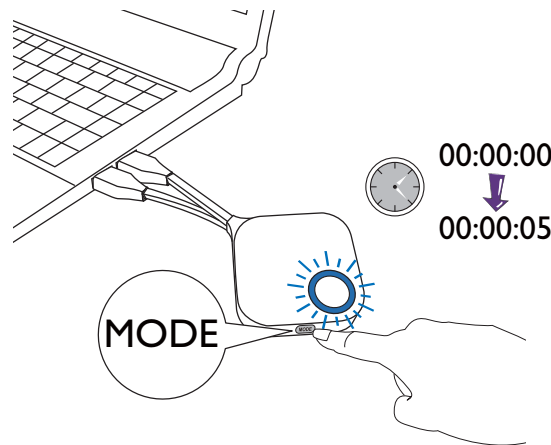

The images are for reference only. Each product has different serial number.

- The LED indicator of InstaShow Button turns static green when InstaShow Host and InstaShow Button are successfully paired.

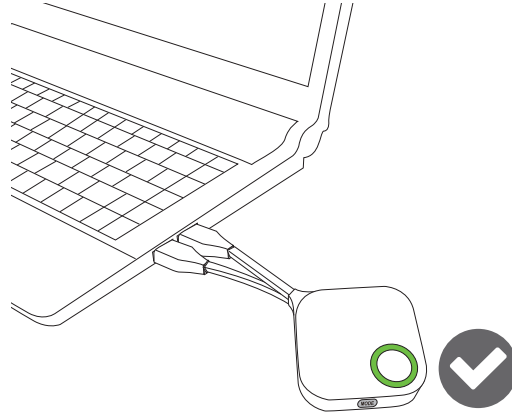

The maximum number of InstaShow Buttons you can pair with one InstaShow Host is 16.

## Waking up InstaShow Host

When InstaShow Host's power indicator turns 50% static green, press Present key of InstaShow Button to start presentation and InstaShow Host will wake up automatically.

## Storing InstaShow Buttons in the cradle

You are provided with two different ways to store InstaShow Buttons in the cradle. Place InstaShow Buttons in the cradle vertically (1) and horizontally (2). See the illustration.

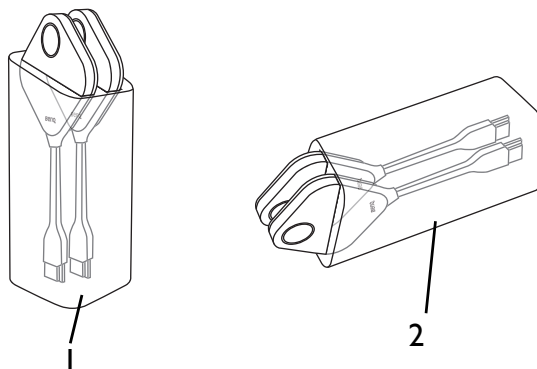

# Starting and stopping presentation

This section will guide you on how to start and stop a presentation using InstaShow™.

## Getting ready

Make sure that all the connected devices have been powered on and ready for the presentation.

As your InstaShow™ could work with different projectors, IFPs, TVs, or monitors with standard HDMI ports, the steps required to start a presentation may vary according to the actual environment and your display specifications. Follow the procedures below and refer to the specified sections for details.

1. To start a presentation, see [Starting presentation on page 19](#) for details.
2. To stop a presentation, see [Idle presentation on page 21](#) for details.
3. To learn more about InstaVideo, see [Play video with InstaShow™ on page 22](#) for details.

## Starting presentation

1. Make sure the power is supplied to InstaShow Host. See [Connecting the HDMI cable and power on page 11](#) for more information.
2. Choose the HDMI source of the display. You can see the Guide screen.

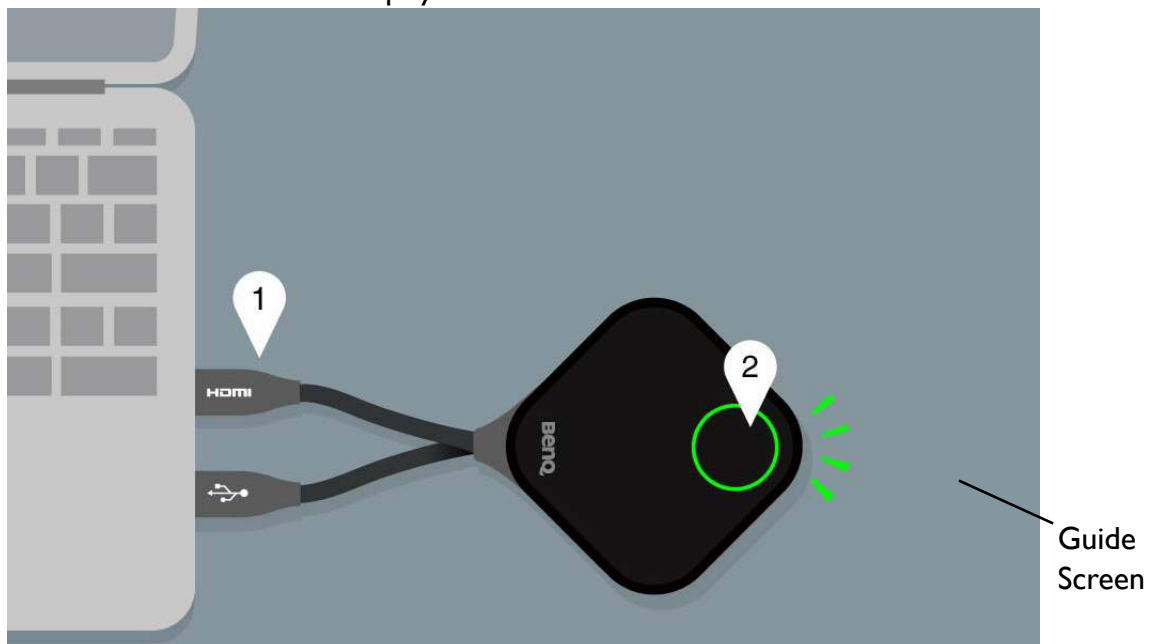

3. Please follow the instruction on the Guide screen to supply power to InstaShow Button. You can also see [Setting up and power supply of InstaShow Button on page 13](#) for more information. The LED indicator of InstaShow Button is in static green when InstaShow Button is connected and working properly. Then you can see the Idle screen.



4. To start presentation, press Present key.
5. The device starts presenting, and the LED indicator of InstaShow Button turns static blue.

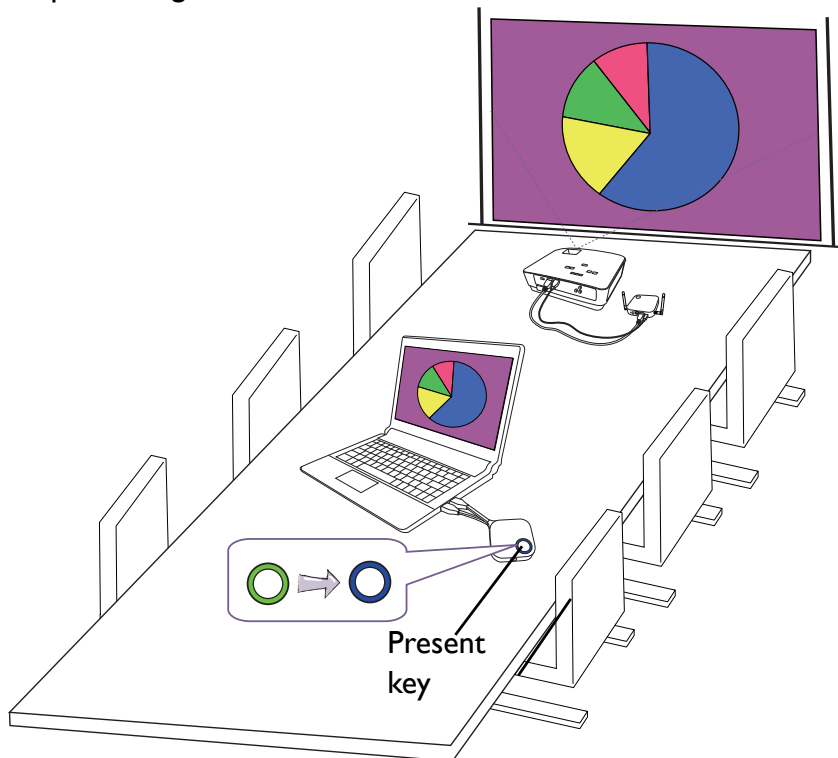

- Make sure the transmission distance between InstaShow Button and InstaShow Host is within 8M and with no obstacles.
- InstaShow™ supports MacBooks and Windows laptops to mirror an extended desktop.

## Idle presentation

1. To stop presentation, press Present key.
2. The device stops presenting, and the LED indicator of InstaShow Button turns green.
3. Users can press Present key to go back to presentation.

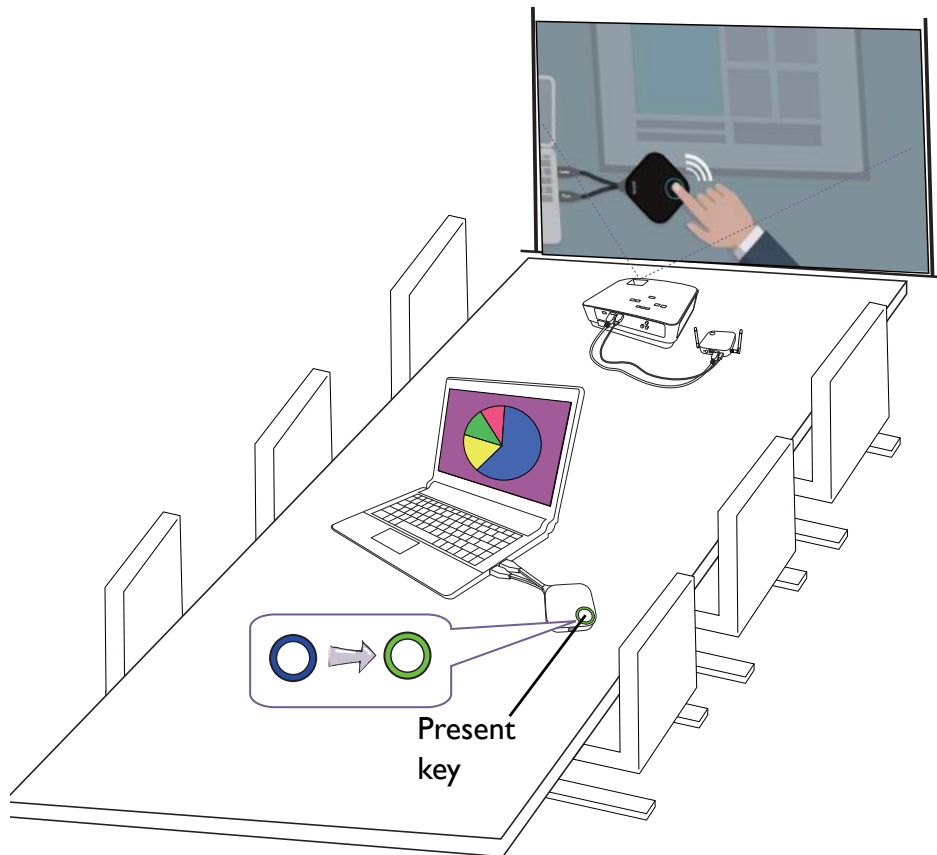

## Play video with InstaShow™

Our exclusive InstaVideo function optimizes InstaShow™'s audiovisual settings to instantly switch from clear **Presentation** mode to smooth **Video** mode with stereo sound at the click of a button without requiring IT support, cable clutter or complex software settings. By enabling presenters to quickly customize the projection for precise productivity or smooth wireless Full HD 1080p video, users can confidently blend text, graphs and charts, pictures, and multimedia audio and video without hesitation for the most effective meetings.

InstaVideo introduces two modes: **Presentation** mode and **Video** mode.

1. The default mode is **Presentation** mode. It presents clear document files.

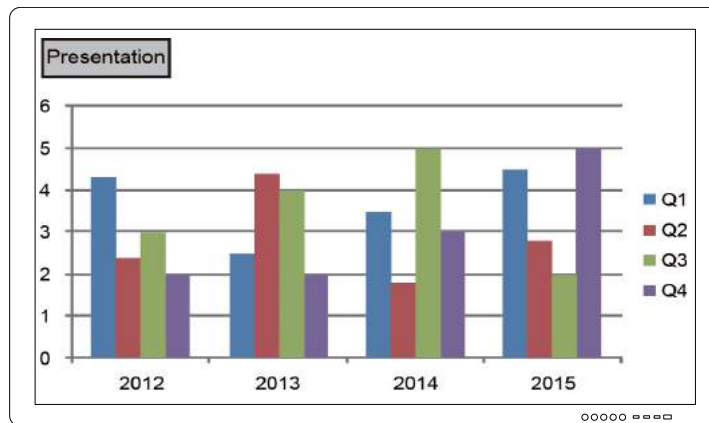

2. If you want to view your full HD 1080p video projected smoothly, switch to **Video** mode by pressing **MODE** key to proceed.



3. You can see the **Video** message on the upper left corner of the screen. Now you can play full HD 1080p videos smoothly.



InstaShow™ is primarily for the use of business presentation with documents such as PowerPoint, Word, Excel, PDF, and Full HD video clips. If users have home theater wireless video display demand, please contact local agent about BenQ WDP02 product for home entertainment usage.

# Troubleshooting

Category	Problem	Cause	Solution
Your screen	Your screen is not appearing on the display when pressing InstaShow button.	The system is locked.	<b>Web Management &gt; Advanced Setting&gt; Screen Lock &gt; Disable</b>
		InstaShow Button is connecting to other InstaShow Host.	InstaShow Button should be paired again with InstaShow Host.
		Pressing time is not enough.	Press the present key until the LED indicator turns from green to blue.
	The screen turns blank or flickers when InstaShow Host is presenting (power connect through USB type A not guaranteed with 5V 1.5A).	Insufficient power supply	Change power supply of InstaShow Host to a power adapter.
	The screen lags seriously and the audio is breaking up sometimes.	Insufficient power supply for InstaShow Button. The old laptop with USB 2.0 port may be used as the power supply for InstaShow Button.	<ul style="list-style-type: none"> <li>• Make sure you use USB 3.0 as the power supply for InstaShow Button.</li> <li>• If the USB 2.0 port is the only option for the power supply for InstaShow Button, try to reduce the power consumption of InstaShow Button by changing <b>Picture Quality Mode to Low Power</b> in the web management.</li> </ul>
		Wi-Fi interference or signal attenuation	<ul style="list-style-type: none"> <li>• Make sure the transmission distance is within 8M and with no obstacles.</li> <li>• Restart InstaShow Host in order to rescan the Wi-Fi 5G channel.</li> <li>• Log in <b>Web Management &gt; Wireless Network &gt; Wi-Fi Radio Setup &gt;</b> toggle the <b>Rescan</b> button.</li> </ul>



Category	Problem	Cause	Solution
Your screen	The message, "No Signal", from InstaShow Host is shown on the display when InstaShow Button is presenting.	The HDMI connection between your laptop and InstaShow Button is loose.	Reconnect the HDMI cable of InstaShow Button.
		Your laptop cannot detect the second monitor.	<ul style="list-style-type: none"> <li>• Reconnect the USB cable of InstaShow Button.</li> <li>• Reboot your laptop.</li> </ul>
	Your screen is shown, but your audio is not playing on the audio system of the meeting room.	The audio signal on your laptop is muted.	Right click on the speaker icon and switch off the mute.
		The audio output of the laptop hasn't been set to the second screen (InstaShow™) from the EDID of InstaShow Button.	Change the default audio output to the second screen (InstaShow™) on the laptop.
InstaShow Button	Your content is removed from the display and the LED indicator of your Button is blinking red.	The wireless connection is lost between InstaShow Button and InstaShow Host.	<ol style="list-style-type: none"> <li>1. InstaShow Host will restore the Wi-Fi connection automatically.</li> <li>2. If this fails, the LED indicator of your Button starts blinking red.</li> <li>3. Unplug the Button from your laptop and try again.</li> </ol>
		Wi-Fi interference or signal attenuation	Make sure the transmission distance is within 8M and with no obstacles.
	The LED indicator of InstaShow Button is blinking red when the power is on.	InstaShow Host has not been turned on.	Make sure InstaShow Host is turned on.
		InstaShow Host has not paired with InstaShow Button.	InstaShow Host should pair with InstaShow Button again.
		Wi-Fi interference or signal attenuation	Make sure the transmission distance is within 8M and with no obstacles.
	The LED indicator of InstaShow Button is always off.	There is no power supply.	Check the USB port of your laptop. If the port fails to function, try other USB ports.

Category	Problem	Cause	Solution
InstaShow Button	InstaShow Button automatically restarts sometimes.	Insufficient power supply	<ul style="list-style-type: none"> <li>• Make sure you use USB 3.0 as the power supply for InstaShow Button.</li> <li>• If the USB 2.0 port is the only option for the power supply for InstaShow Button, try to reduce the power consumption of InstaShow Button by changing <b>Picture Quality Mode</b> to <b>Low Power</b> in Web Management.</li> </ul>
InstaShow Host	Nothing is shown on the display at all.	The display is switched off.	Switch on the display.
		The wrong input is selected.	Select the correct input.
		The display cable is not connected properly.	Insert the HDMI cable between InstaShow Host and the display device again.
		The display fails to show InstaShow Host's output resolution at 720p in "Guide Screen" or "Idle Screen".	Replace the display with a new one that supports output resolution at 720p.
		InstaShow Host is in <b>Network Standby Mode</b> when network standby function is enabled.	Press present key of InstaShow Button to start presentation.
		InstaShow Host is in <b>HDMI Standby Mode</b> when HDMI standby function is enabled.	Briefly press the power button on InstaShow Host or power on the display (connected to InstaShow Host with an HDMI cable). InstaShow Host will wake up automatically.
		InstaShow Host is powered off.	Briefly press the power button on InstaShow Host.
		Insufficient power supply	Change power supply of InstaShow Host to a power adapter.

Category	Problem	Cause	Solution
EDID	After connecting InstaShow Button to your laptop, the second screen (InstaShow™) cannot be detected.	The HDMI connection between your laptop and InstaShow Button is loose.	Reconnect the HDMI cable of InstaShow Button.
		Laptop problem	Reboot your laptop.
		InstaShow Button is shutdown.	Reconnect the USB cable of InstaShow Button.
Pairing	The message, "Pairing failed", from InstaShow Host is shown on the display when InstaShow Host is pairing with InstaShow Button.	1. Error: 004 2. InstaShow Host has reached the maximum number of pairing.	Log into the web management, then select <b>Pairing Status &gt; Delete</b>  Delete unnecessary pairings.
		Wi-Fi interference or signal attenuation	Make sure the transmission distance is within 8M and with no obstacles.
		InstaShow Button has not entered the pairing mode in time.	When InstaShow Host enters the pairing mode, InstaShow Button should also enter the pairing mode within two minutes.
Windows Software	When presenting a video file via Gom Media Player, the full-screen image is cut into upper and lower halves.	Media player	Use other media players to play video files, such as Windows Media Player.
Web management	Cannot Log in	Forget the account and password.	1. Reset InstaShow Host. 2. The default log in account: admin 3. The default log in password: 0000.
	Laptop cannot connect the SSID with the correct password by Wi-Fi.	Laptop Wi-Fi module cannot support 802.11 AC.	Laptop can connect InstaShow Host with an Ethernet cable instead of Wi-Fi connection.

# Product specification

Feature			
Color	Black		
Video outputs	HDMI 1.4, comply with HDCP		
Frame Rate	Up to 30fps depending on environment		
Output resolution	Video Timing: 1280x720 (720P), 1920x1080 (1080p) PC Timing: 800 x 600, 1024 x 768, 1280 x 768, 1280 x 1024, 1280 x 960, 1360 x 768, 1440 x 900, 1400 x 1050, 1680 x 1050		
Input resolution	Up to 1920x1080		
Number of simultaneous connections	16 pcs		
Audio	Stereo, Radio quality 16bits 48KHz		
Wireless transmission protocol	IEEE 802.11ac, 5GHz, 2T2R		
Data rate wireless	Up to 400Mbps		
Frequency Band	5GHz		
Authentication protocol	WPA2 (WPAS-PSK (Pre-Shared key) / WPA2-Enterprise)		
Security (encryption)	AES 128 bit		
Support platform	Windows, MAC, Chrome. Any OS supports HDMI standard 1.4		
Reach	Max. 8M between InstaShow Button and InstaShow Host		
Temperature range	Operating: 0°C to +40°C (+32°F to +104°F)		
	Storage: -10°C to +60°C (+14°F to +140°F)		
Humidity	Storage: 5% to 90% relative humidity, non-condensing		
	Operation: 10% to 80% relative humidity, non-condensing		
InstaShow Button			
Cable	USB Type A, HDMI Cable	Power supply	DC 5V±10%, 0.9A
Reset button	x1	Power consumption	normal: 4.5W
Mode key	x1	Dimension	84.5*189.55*19.9mm
LED	Red (booting), Green (Wi-Fi connected), Blue (presenting)	Weight	100g
InstaShow Host			
Power button	x1	Power supply	DC 5V±10%, 1.5A
Pairing key	x1	Power consumption	Normal: 5W
LAN	x1 (10/100 Mbps)		Network standby: 2W
Video output	x1 HDMI 1.4 (video and audio)		HDMI standby: 0.02W

Feature			
DC Power Jack	x1 (micro USB)	Dimension	110*110*27mm (99mm with antenna, not include antenna and rubber foot)
LED	Red (booting), Green (ready for connection), Blue (presenting)	Weight (include antenna)	150g
Cradle			
Dimension	85*97.5*170.4mm	Weight	630g