



Features

X-Sign Content Management Software

BenQ's integrated, exclusive X-Sign software provides 100+ content templates, making it easy for operators to quickly design and roll out new promotional material. The templates also let operators add images, videos, and scrolling text to their marketing materials. X-Sign's intuitive interface makes it easy for operators to monitor and manage all remote displays from a central, off-site location. It allows operators to push real time messages, to make instant price updates and broadcast YouTube live streaming across multiple displays. X-Sign allows operators to embed QR Codes that, when scanned, can offer customers the latest promotional information. X-Sign also offers QR Code analysis to let operators see when and where customers are interacting with content. This analysis can help operators quickly adjust their offers to match customer interest.

Performance

An ultra-high definition resolution of 4K2K (3840 x 2160) offers the most exquisite image details and allows for flexible colour adjustment to display captivating images. ST6502 features 450 nits of high brightness and an anti-glare screen that reduces reflection, thus enhancing visibility for both indoor and outdoor use.

Intuitive Design

A slim and lightweight design combined with a narrow bezel delivers a stylish outlook befitting of any in-store environment. It can easily be mounted to suit diverse uses, which saves cost and manpower on signage installation and eventually facilitates different display configurations in stores, offices, and other commercial establishments.

Hassle-free Display Management

With Device Management Solution operators can remotely control display on/off time or backlight via LAN. Over-the-Air Update allows to have the latest version of display drivers installed at all times with effortless firmware updates. DMS Cloud gives operators control of all devices in the store and lets them install Android apps and distribute content via cloud server.

Input and Output Terminals

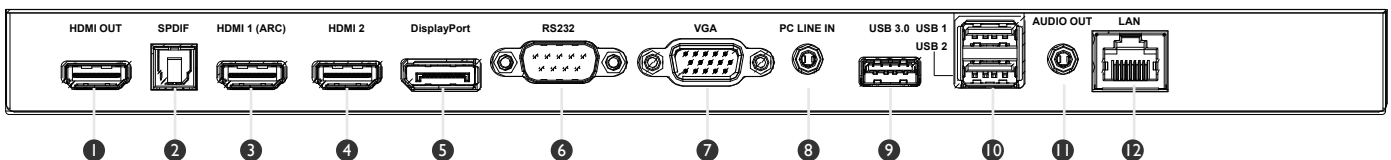

- | | | |
|----------------|-----------------|----------------|
| ① HDMI Output | ⑤ DisplayPort | ⑨ USB 3.0 |
| ② SPDIF | ⑥ RS232 | ⑩ USB 1 & 2 |
| ③ HDMI 1 (ARC) | ⑦ VGA | ⑪ Audio Output |
| ④ HDMI 2 | ⑧ PC Line Input | ⑫ LAN |

ST6502
65" Smart Signage

BenQ

Specifications

Panel	Screen Size	65"		
	Resolution	3840 × 2160		
	Brightness (Typ.)	450 nits		
	Contrast Ratio (Typ.)	1200 : 1		
	Viewing Angle (H/V)	178 / 178		
	Response Time (G-t-G)	8		
	Backlight Life (hrs)	30,000		
	Panel Surface	Anti-Glare		
	Operating Hours	18 / 7		
Power	Orientation	Landscape		
	Type	Internal		
	Power Supply	100V~240V, 50 Hz / 60 Hz		
	Power Consumption	Maximum (W/h)	320W	
		Typical (W/h)	300W	
Standby Mode (W/h)		≤0.5W		
Off Mode (W/h)		≤0.5W		
Wake up	HDMI / VGA			
Environment	Operation Temperature	0°C ~ 40°C		
	Operating Humidity	20% ~ 90% RH non-condensing		
Connectivity	Input	VGA	× 1	
		HDMI	HDMI 2.0 × 2	
		Display Port	DP 1.2 × 1	
		Audio Input	× 1 (3.5mm)	
		Output	HDMI	HDMI 2.0 × 1
	Audio Output	× 1 (3.5mm)		
	USB	USB 3.0 × 1		
		USB 2.0 × 2		
	RS232	Yes		
RJ45	Yes			
Remote Controller	Yes			
Audio	Internal Speaker	12W × 2		
Mechanical	Dimensions (mm)	Screen	1450.6 × 828.1 × 78.5	
		Package	1605 × 965 × 220	
	Weight (kg)	Screen	22,9	
		Package	33,6	
	Bezel Width (mm)	8.8 (Top / Side), 12.8 (Bottom)		
	Wall Mounting (VESA) (Screw Type /Max. Length)	400 × 200 mm M6 × 10 mm		
OPS	Yes			

Dimension (mm)

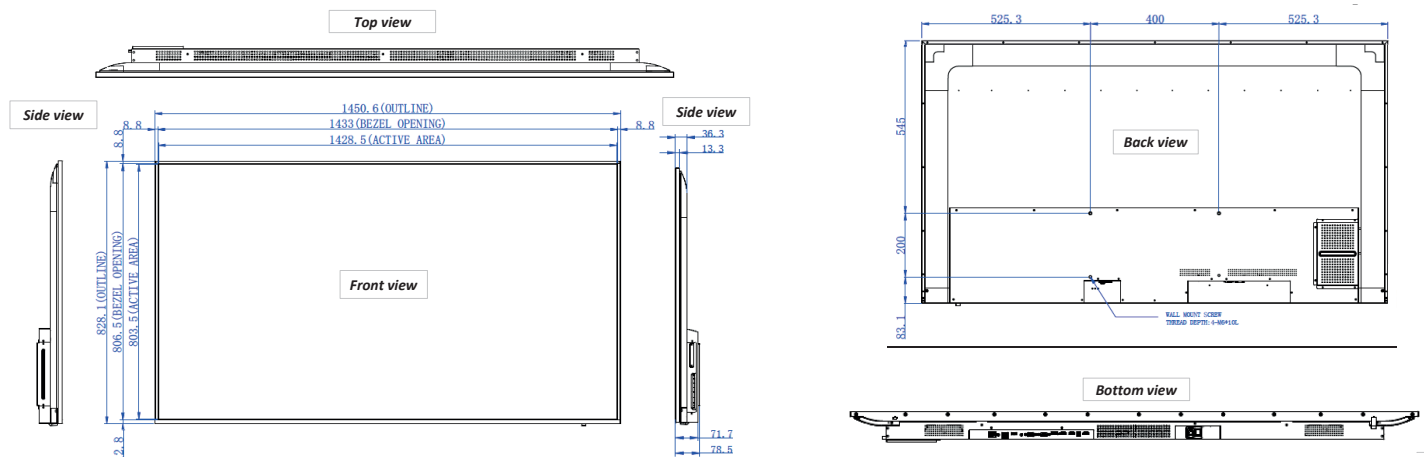

BenQ Europe B.V.

Meerenakkerweg 1-17
5652 AR Eindhoven
The Netherlands
Tel: +31 88 8889200

business-display.benq.eu

© 2020 BenQ Corp. Specifications may vary by region, please visit your local stores for details. Actual product's features and specifications are subject to change without notice. This material may include corporate names and trademarks of third parties which are the properties of the third parties respectively.

BENQ